

This article was downloaded by:

On: 25 January 2011

Access details: *Access Details: Free Access*

Publisher *Taylor & Francis*

Informa Ltd Registered in England and Wales Registered Number: 1072954 Registered office: Mortimer House, 37-41 Mortimer Street, London W1T 3JH, UK



Journal of Macromolecular Science, Part A

Publication details, including instructions for authors and subscription information:

<http://www.informaworld.com/smpp/title~content=t713597274>

Mechanism of Organic Layer Formation in Low-Pressure Plasmas: Layer Formation in the Positive Column with Styrene

H. -J. Tiller^a; D. Berg^a; D. Herzberg^a; K. Dumke^a

^a Sektion Chemie Friedrich- Schiller- Universität, Jena, DDR

To cite this Article Tiller, H. -J. , Berg, D. , Herzberg, D. and Dumke, K.(1977) 'Mechanism of Organic Layer Formation in Low-Pressure Plasmas: Layer Formation in the Positive Column with Styrene', *Journal of Macromolecular Science, Part A*, 11: 3, 547 – 576

To link to this Article: DOI: 10.1080/00222337708061288

URL: <http://dx.doi.org/10.1080/00222337708061288>

PLEASE SCROLL DOWN FOR ARTICLE

Full terms and conditions of use: <http://www.informaworld.com/terms-and-conditions-of-access.pdf>

This article may be used for research, teaching and private study purposes. Any substantial or systematic reproduction, re-distribution, re-selling, loan or sub-licensing, systematic supply or distribution in any form to anyone is expressly forbidden.

The publisher does not give any warranty express or implied or make any representation that the contents will be complete or accurate or up to date. The accuracy of any instructions, formulae and drug doses should be independently verified with primary sources. The publisher shall not be liable for any loss, actions, claims, proceedings, demand or costs or damages whatsoever or howsoever caused arising directly or indirectly in connection with or arising out of the use of this material.

Mechanism of Organic Layer Formation in Low-Pressure Plasmas: Layer Formation in the Positive Column with Styrene

H.-J. TILLER, D. BERG, D. HERZBERG, and K. DUMKE

Sektion Chemie
Friedrich-Schiller-Universität
Jena, DDR

ABSTRACT

The formation of organic layers by decomposition of styrene in the positive column of a glow discharge is studied by a complex analysis of the gas phase and of the layer. The positive column is used as a flow tube whereby time resolution of layer formation and decomposition of styrene as monomer is possible. The product distribution qualitatively is independent of discharge conditions. Quantitatively a dependence of a parameter called specific decomposition energy ϵ_v exists. The composition and properties of the layer depend on the parameter ϵ_v and a second parameter ϵ_{vw} , termed the specific cross-linking energy. A model of layer formation is proposed which includes some different models discussed in the literature which are specific cases of this general model. The different cases depend on the parameters mentioned above. Methods used for analysis of the layer are gas chromatography, mass spectroscopy, IR spectroscopy, EPR spectroscopy, solvent

fractionation, elementary analysis, molecular weight determination, thermal investigations, and electron microscopy.

INTRODUCTION

If organic compounds are mixed with low-pressure plasmas, layers develop on the plasma boundary surfaces or on suitably mounted substrates. Because of their chemical resistivity and the defined dependence of their thickness on plasma parameters and discharge time, such layers aroused industrial interest in their application as dielectrics or passivating films, which is reflected by a number of patents [1-3]. Simultaneously more or less systematic investigations were begun, including experiments to obtain layers of varying properties from different initial compounds [4-13] as well as phenomenological studies of the influence of initial compound, plasma parameters [4, 7, 10, 13-22] and plasma carrier gas [5, 7, 23-26, 50] on layer formation. Several investigations into the morphology of the layers were also reported [5, 27-33]. From the results, conclusions were derived on the mechanism of layer formation, proceeding from the assumption of a quasi-polymeric layer structure, primarily because spectroscopic studies suggested parallels to block polymers. Therefore, mechanism discussions are frequently based on polymer-kinetic concepts, with both radical [6, 12, 16, 17] and ion [10, 32] mechanisms being proposed.

Most of the reports cited also refer to the complexity of the substance mixture to be discussed. Mechanism discussions differ further as to the assumed site of macromolecular product formation. Several authors prefer to discuss layer formation on the surface [4, 7, 20, 21, 35, 37, 38], whereas others, most of them relying on morphological studies, advocate higher molecular product formation in the gaseous phase [5, 24, 25, 32, 36]. Apart from the fact that the geometry, nature of discharge, and characteristics of low-pressure plasmas, in particular, permit their properties to vary through a wide range of conditions affecting layer formation (which makes the comparative evaluation of results obtained by different workers extremely difficult), there are a number of facts that contradict simplified mechanism concepts based on volume polymer growth kinetics. Studies on gaseous-phase decomposition of organic initial substances in the plasma reveal a broad spectrum of reaction products [37, 39-44], which can be expected to contribute differently to layer formation. Moreover, investigations into layer formation in a flow tube [7, 22] or in flowing gases [7, 12, 23] support the assumption that,

in general, layer formation occurs through intermediate states in the gaseous phase, unless the discharge geometry employed and the prevailing pressure and diffusion conditions permit the direct conversion of the initial compound on the surface, such as in layer formation by electron beams [45]. It is, in fact, the gaseous-phase concept that implies the possibility of layer formation even from saturated compounds. There are indications also that different vinyl compounds do not differ greatly in their layer-forming behavior, so that vinyl group is believed to have no decisive part in layer formation [6, 46]. The concept of layer formation through intermediate products, notably of very low saturation, is maintained by some authors [12, 22].

Styrene, next to benzene, has been studied most thoroughly as an initial compound. A great number of experiments with varying discharge modes have been reported [10, 23, 32]. Those made by Thompson [32] deserve special mention, because they employ a broad spectrum of methods for studying the layers formed in HF discharges. All these works, too, discuss mechanism on the basis of a polymer-kinetic growth concept.

The subject of the present report is a combined investigation into gaseous phase and layer formation, coupled with time resolution in a plasma flow tube, with the objective of discussing mechanism in more detail. Also, the use of styrene as initial compound enables individual results to be compared with others reported in the literature and obtained under different conditions, which may provide an answer to the question whether mechanism concepts can be generalized.

The positive column of a glow discharge is the most thoroughly known of all plasma parts; its use here is based on its homogeneity, which makes it especially suitable for flow tubes.

EXPERIMENTAL

Figure 1a shows a schematic diagram of the experimental setup. A variable proportion of styrene was admixed to a constant flow of argon ($V = 30$ cm/sec, $p = 0.5$ Torr). The styrene flow was varied between 10^{-5} and 10^{-3} mole/min. Monomer transport through the flow tube at high throughput ($D_M > 3 \times 10^{-6}$ mole/sec) is determined by gas flow, at low throughput ($D_M < 6 \times 10^{-7}$ mole/sec) by diffusion. The proportions of two cases can be established by experiment from layer formation in, and against, the direction of flow and calculated quantitatively from the pressure and throughput values. The graphs show the results transformed into the time axis.

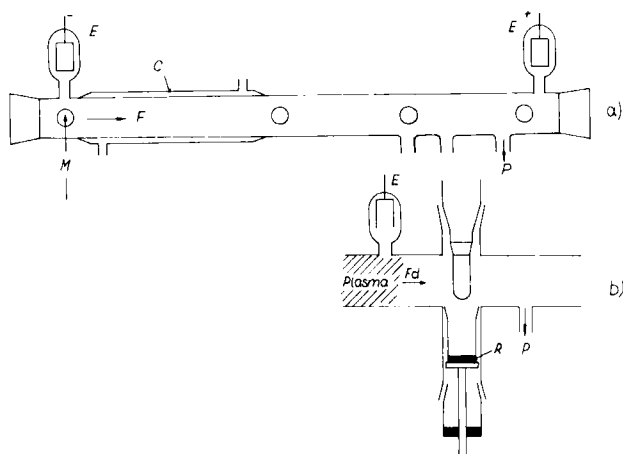

FIG. 1. Schematic diagrams of (a) plasma flow tube and experimental setup and (b) sampling device for gaseous phase analysis: (E) electrode; (F) flow distance; (Fd) flow direction; (P) pump; (R) rubber membrane; (M) monomer; (C) cooling jacket.

Polished glass substrates ($1 \times 10 \times 250$ mm) were inserted into the flow tube. Lines were scribed into the deposited layers and their thickness measured with a surface tester. From the results, the $P_r(t)$ functions [$\text{\AA}/s$ as $f(t_d)$, where t_d is monomer decomposition time] can be derived. The tube wall is surrounded by a jacket for thermostating within the range $15\text{--}85^\circ\text{C}$.

Methods of layer analysis included IR spectroscopy, elementary analysis, gas chromatography, molecular weight determination, pyrolysis chromatography, and thermal measurements. Selected samples were scanned by EPR and DSC techniques. Layer samples were taken from various portions of the flow tube and separated by benzene into a soluble and an insoluble portion (a). By precipitation in methanol, the benzene-soluble portion was again fractionated into a higher molecular fraction insoluble in methanol (b) and a methanol-soluble fraction (c). Attached to the plasma flow tube at defined distances are stems, which may hold either a movable electrode in order to vary the length of the plasma column, or the sampling device for gaseous-phase products (Fig. 1b). A cooling finger filled with liquid nitrogen causes the gaseous-phase products leaving the plasma column to condense on the finger surface. Once the plasma decomposition is completed, a sleeve is pushed over the cooling finger in the

vacuum and the sampling device separated from the flow tube. Both gaseous and liquid products can be sampled through the rubber membrane by means of an injection syringe and fed into the gas chromatograph.

RESULTS AND DISCUSSION

Investigation of the Gaseous Phase

The gaseous phase was studied by its products condensed on a cooling finger (Fig. 1b) located outside the plasma column. The reaction products gaseous at room temperature consisted essentially of C₂ compounds (ethylene, acetylene). The liquid phase was a multicomponent system whose composition remained qualitatively constant throughout the range of plasma parameter settings while quantitatively varying systematically with plasma conditions and decomposition time. Figure 2 shows a typical chromatogram of the liquid mixture. Compounds of higher molecular weights than those corresponding to styrene dimers cannot be detected, even when the discharge conditions were varied. This is due to the fact that the higher the molecular weight of a compound, the less probable is its formation; moreover, these substances may condense already on the wall of the plasma tube.

The total quantity of reaction products systematically depends on the throughput and decomposition time of the initial compound (Fig. 3a). It is a rough measure of the degree of styrene conversion and correlates with the specific plasma energy introduced in [22], which is defined as

$$\epsilon_V = V_{pl} \left(\frac{V_s i}{N_A D_M} \right) [Ws/particle] \quad (1)$$

where $V_{pl} = F\ell$

= plasma volume (cross section \times length of column)

= FVt_d

(where V is flow rate and t_d is decomposition time)

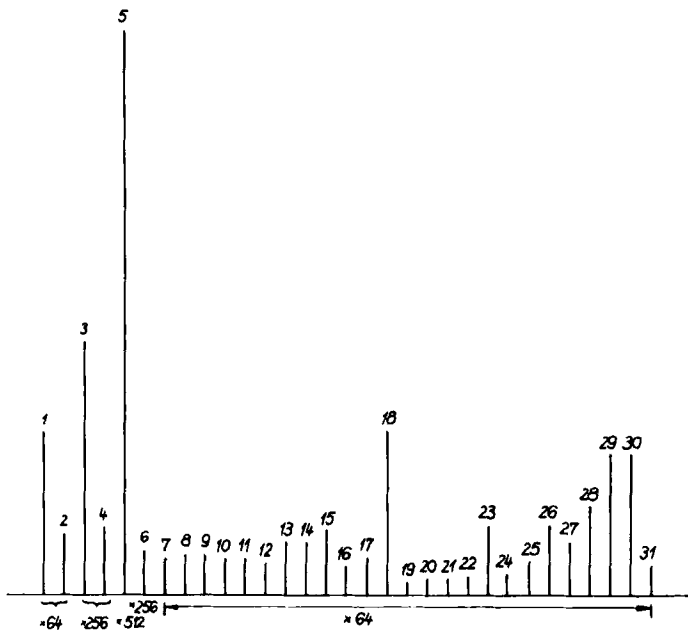
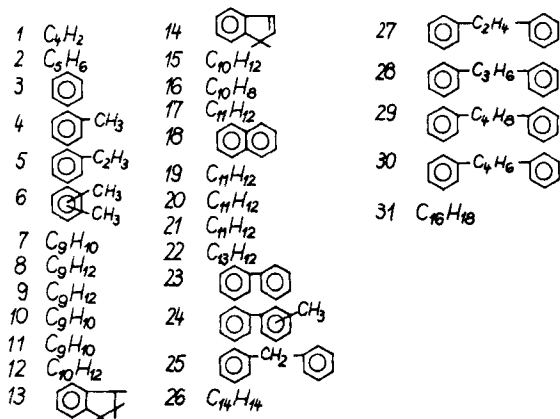

FIG. 2. Gas chromatogram of the liquid phase of gaseous phase products.

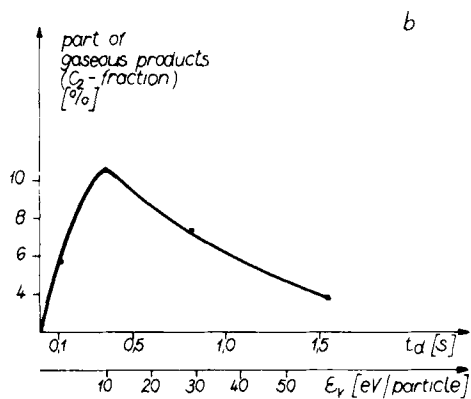
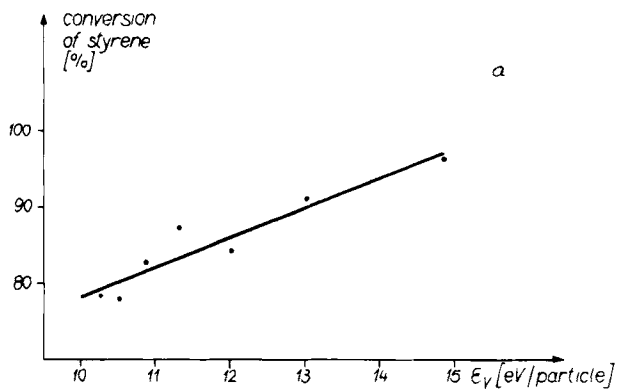

FIG. 3. Plots of (a) styrene conversion as a function of specific plasma energy ϵ_v , $i = 5 \text{ mA/cm}^2$; $t_d = 0.34 \text{ sec}$; (b) yield of low molecular gaseous phase product (C_2 -fraction) as a function of decomposition time t_d , $i = 5 \text{ mA/cm}^2$, $D_M = 1.3 \times 10^{-5} \text{ mole/sec}$.

and V_s is field strength (V/cm), i is current density (A/cm^2), N_A is Avogadro's constant, and D_M is the monomer throughput (mole/sec). Thus, under constant plasma conditions,

$$\epsilon_v = A(t_d/D_M)$$

A similar quantity, proving characteristic for plasma-chemical investigations, was also proposed by Neiswender [47]. For a single product such a relation is not to be expected because taking place a superposition of different processes of formation and destruction. For instance, the quantity of gaseous reaction products first increases with ϵ_V or t_d , respectively (Fig. 3b), but then decreases as the products themselves are converted into solid layer material.

Figure 4 shows the relative concentration changes of some reaction products as function of throughput or specific plasma energy. The selection includes products that may well have been formed by way of varying number of decomposition and combination reactions. Compounds formed by few reaction stages, especially by the reaction of primary styrene fragments with styrene or hydrogen depend little on throughput. Examples are benzene, diphenylbutane, and diphenylbutene. Compounds whose formation can be explained only by a multitude of intermediate stages show greater dependence on D_M or ϵ_V (e.g. naphthalene, toluene).

Based on general pattern with three essential stages of conversion, viz., formation of primary reaction products by dissociation and ionization reactions of the initial compound, reaction of these primary products with the redundant monomer up to synthesis reactions, and reactions among reaction products, the primary radicals for styrene as initial compound can be assumed to be $C_6H_5\cdot$, $\cdot CH=CH_2$, H, and styrene radicals formed by hydrogen abstraction. The double bond in the vinyl group and the ring are very stable to the electron impact dissociations that exclusively qualify for the primary processes [48].

Under the prevailing discharge conditions, ion concentration is 4 to 5 orders of magnitude below radical concentration, so that ion reactions should not dominate conversion despite their higher reaction rate.

On the basis of these primary radicals, a reaction pattern can be assumed for the formation of the most frequent reaction products: C_4H_2 , C_2H_4 , $(C_6H_5)_2$, $C_6H_5CH_3$, $C_6H_5C_2H_5$, $C_6H_5-C_4H_8-C_6H_5$, $C_6H_5-C_4H_6-C_6H_5$, $C_6H_5-C\equiv CH$, naphthalene. A detailed discussion of this mechanism was given previously [61]. Some steps in this pattern must be regarded as summary reactions for which, in principle, ionic reactions are also possible under different discharge conditions, especially where monomer proportion in the plasma is small [49].

Phenomenological Studies of Layer Formation

The growth rate P_r of the layers depends markedly on throughput D_M and on the decomposition time of the initial compound in the plasma.

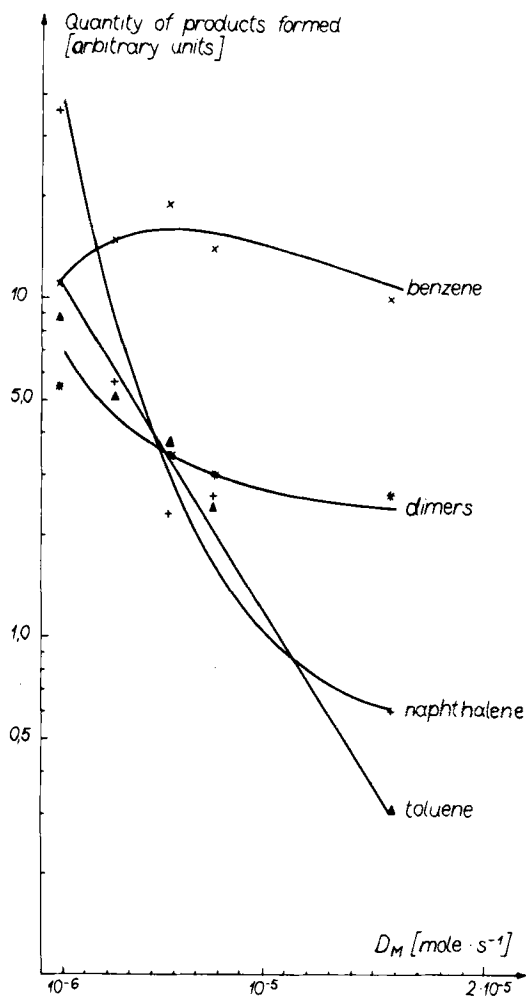
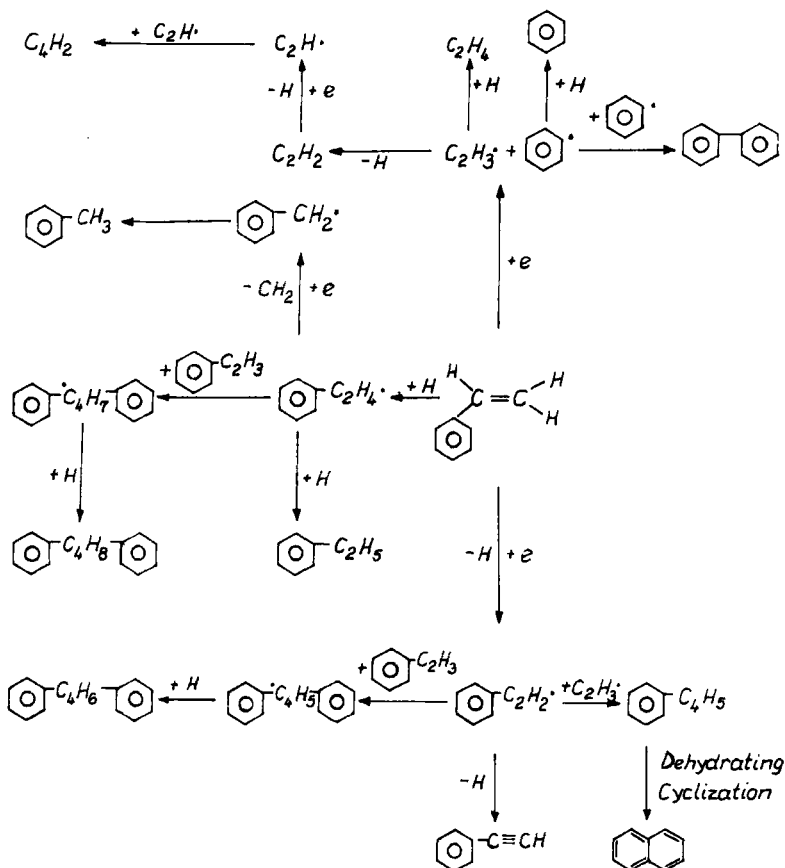

FIG. 4. Dependence on D_M of concentration of some gaseous phase products.



With a plasma flow tube as shown in Fig. 1a the $P_r(t)$ functions presented in Fig. 5 are obtained. They have maxima that vary with throughput, which provides unmistakable evidence that the layers are formed from reaction products of styrene rather than by direct conversion of styrene on the substrate surface. In addition, the $P_r(t)$ behavior depends on wall temperature and discharge current density (Fig. 6). The maximum shifts towards longer decomposition times as the wall temperature increases (Fig. 6a), while shifting towards shorter decomposition times as current density increases (Fig. 6d), which is due to the faster rate of reaction product formation.

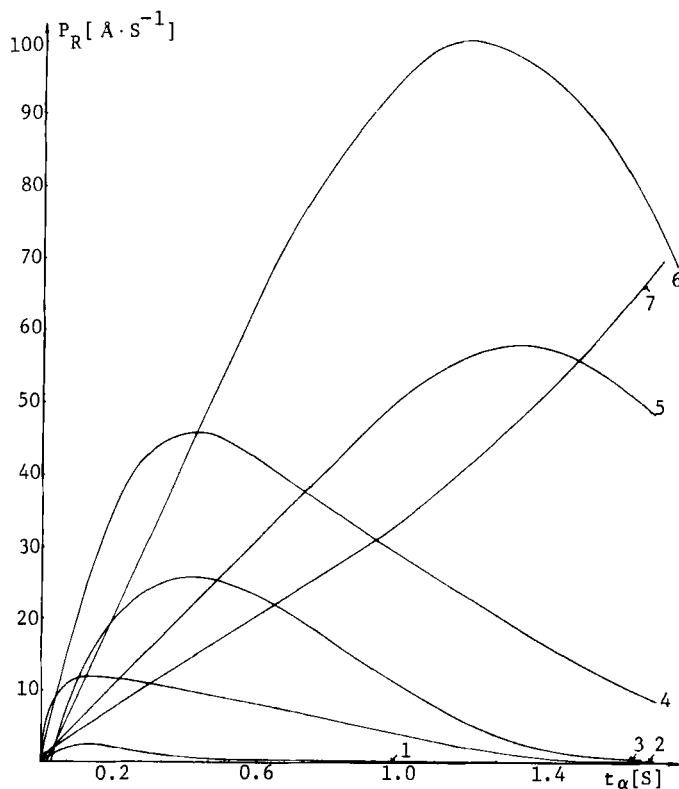
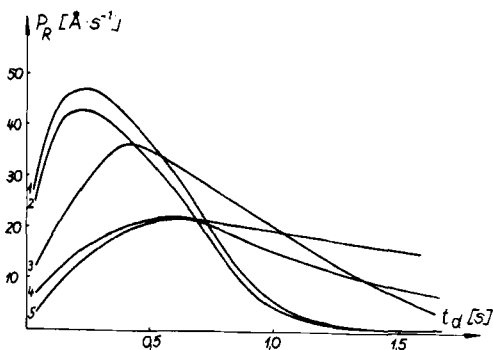

FIG. 5. $P_R(t)$ functions vs. monomer throughput for styrene as initial compound: (1) $D_M = 7.20 \times 10^{-8}$ /mole, $k_3 = 6.1$ /sec; (2) $D_M = 6.34 \times 10^{-7}$ /mole, $k_1 = 5.1$ /sec, $k_3 = 5.9$ /sec; (3) $D_M = 1.30 \times 10^{-6}$ /mole, $k_1 = 5.6$ /sec, $k_3 = 6.5$ /sec; (4) $D_M = 3.80 \times 10^{-6}$ /mole, $k_1 = 2.4$ /sec, $k_3 = 3.4$ /sec; (5) $D_M = 7.30 \times 10^{-6}$ /mole, $k_1 = 0.5$ /sec, $k_3 = 1.4$ /sec; (6) $D_M = 1.15 \times 10^{-5}$ /mole, $k_1 = 0.9$ /sec, $k_3 = 1.8$ /sec; (7) $D_M = 1.83 \times 10^{-5}$ /mole.

a)



b)

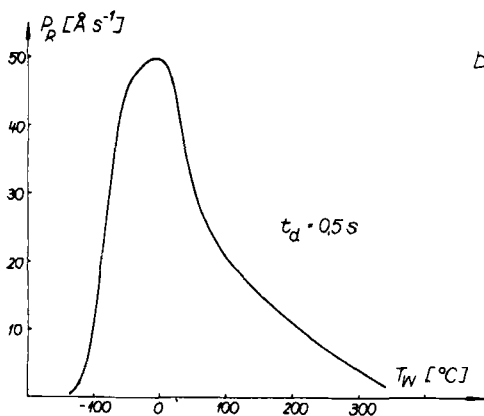
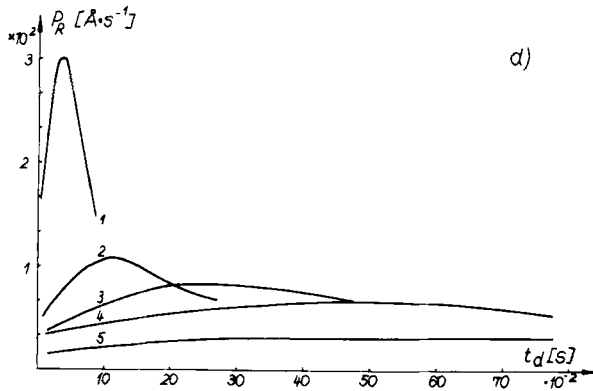
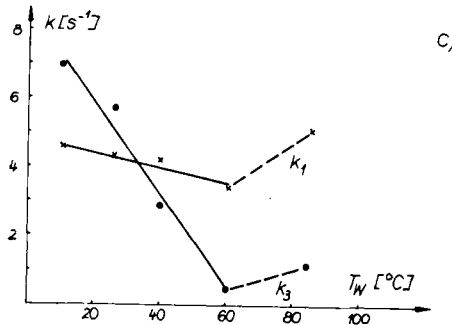

FIG. 6. Effects of wall temperature and current density: (a) effect of wall temperature on $P_r(t)$ at various temperatures: (1) 1.5°C, (2) 26°C, (3) 40°C, (4) 60°C, (5) 84°C; (b) effect of wall temperature on P_r at fixed t_d .

As Fig. 6 reveals, the influence of wall temperature on layer formation, which was investigated by several authors [4, 7, 20, 24, 32, 34], is found to vary also with decomposition time. Because of the time-dependent spectrum of reaction products the influence of wall temperature on a fixed substrate arrangement can therefore be generalized with difficulty. Evidence of the importance of adsorption in the process of layer formation and thus of the wall temperature was discussed in several works, one of which [62] also treats condensation on the wall.



(c) k_1 and k_3 as functions of wall temperature; (d) $P_r(t)$ as function of current density: (1) 5.33 mA/cm^2 , (2) 20.1 mA/cm^2 ; (3) 11.2 mA/cm^2 , (4) 6.3 mA/cm^2 , (5) 4.0 mA/cm^2 .

Also, the $P_r(t)$ maxima found in a number of components essentially account for the dependence of layer formation rates on monomer throughput discovered by some authors [4, 7].

A discussion of $P_r(t)$ -functions requires the plasma parameters in the flow tube to be approximately constant in space. Investigations [49] on the influence of organic components on electron density (n_e) and electron energy proved a strong influence in case of small admixtures (<1%), which is accounted for by the Penning ionization of the

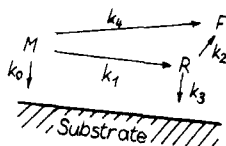

FIG. 7. Model used for kinetic evaluation. M denotes initial compound; R denotes layer-forming reaction products; F denotes products not forming layer.

benzene admixture employed in that experiment. Higher admixtures (up to 20%), however, resulted in no significant changes in the plasma parameters mentioned. These results, obtained with stationary discharges, are supported by studies [51, 52] on the spatial dependence of the parameters in flowing HF/noble gas plasmas. Our own experiments made to establish the dependence of field strength in the positive column on the time of monomer decomposition also suggest the approximate stability of the parameters within half an order of magnitude. These n_e values were estimated to be 10^{10} cm^{-3} .

The kinetic evaluation follows a simple model concept (Fig. 7) put forward elsewhere [22].

Applying first-order time laws to simplify matters, we obtain the following solution for the growth rate $P_r(t)$:

$$P_r(t) = A [M]_0 \left[k_0 e^{-(k_0 + k_1 + k_4)t} + \frac{k_1 k_3}{k_0 + k_2 + k_4 - (k_2 + k_3)} (e^{-(k_2 + k_3)t} - e^{-(k_0 + k_1 + k_4)t}) \right]$$

Considering the total conversion, additional information such as the significance of constants k_2 and k_4 may be obtained. In the flow tube employed, up to 90% of the styrene is converted into layer material, so that only k_0 , k_1 , and k_3 remain as important constants. These constants characterize the layer-forming behavior of a certain compound better than the commonly used growth rate, which is determined at a single site. Because of the specific $P_r(t)$ function of the initial compound, different plasma setups and varying flow conditions may yield widely differing information where compounds are compared to each other.

In Figures 5 and 6c note the k values for various $P_r(t)$ functions. They are constants that summararily reflect a multitude of reaction stages.

Expectedly, the influence of wall temperature is particularly strong on constant k_3 , which characterize wall reactions (Fig. 6c). The rise at higher temperatures might be caused by thermal polymerization effects.

Studies on the Layers Formed

IR spectroscopy is one of the most frequently used methods to characterize organic layers formed in a plasma. Figure 8 shows the IR spectrum of a layer produced from styrene, scanned immediately after its formation (a), and after 14 days of storage in air (b). Detailed studies on aging are reported elsewhere [53].

From the similarity of some individual bands of the layer with those of polystyrene, some workers in the field have occasionally inferred a quasi-polystyrene structure of the layer. Owing to the highly complex composition of the gaseous phase, however, the layer must also be expected to contain a mixture of substances, which is verified by the gas-chromatographic tests described below. For that reason, the IR spectra of the layers are suitable for obtaining information on the existence or alteration of certain characteristic structural elements, such as the aliphatic/aromatic ratio and oxidizability.

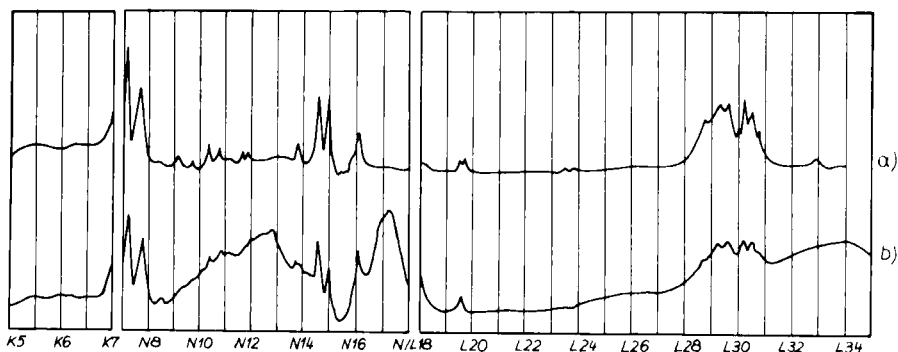

FIG. 8. IR spectra of an organic layer formed from styrene: (a) immediately after layer formation; (b) after 14 days of exposure to air.

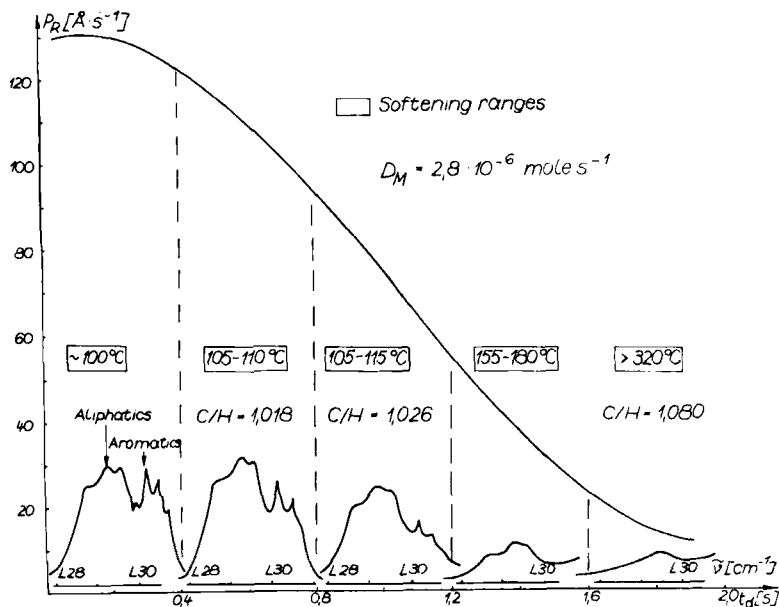

FIG. 9. C/H ratio and aromatic/aliphatic ratio in various segments of $P_r(t)$ function.

Layer oxidation gives rise to new bands, so that IR spectra can change markedly during the aging process.

The composition of the layers also depends on the degree of decomposition of the initial compound. Different portions of the $P_r(t)$ functions of a layer show changes in the aromatic/aliphatic and C/H ratios (Fig. 9). The change in C/H ratio, which is unity for layers of styrene origin through a wide variety of layer-forming conditions, was reproduced in a multitude of test series. The change indicates a faster rate of layer formation from dehydrated reaction products and supports the role of dehydration reactions in plasma gas discharges detected by many workers [12, 14, 40, 41, 54].

If the layer, however, is separated as described above into an insoluble, higher-molecular fraction (a), a benzene-soluble fraction (b) a methanol-soluble, low molecular weight fraction (c), a likewise systematic dependence on the parameter D_M is found (Fig. 10).

Table 1 lists some results obtained on individual fractions, which

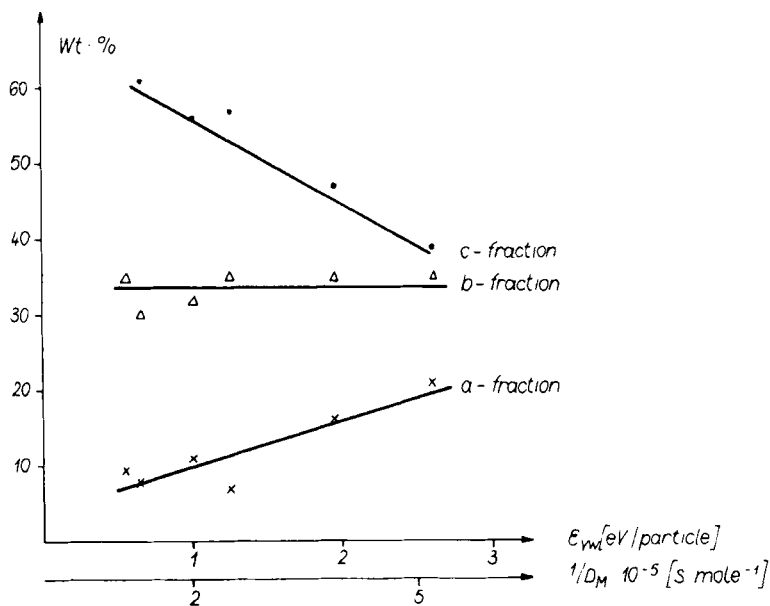

FIG. 10. Proportions of layer fractions in the total layer as a function of ϵ_{vw} .

TABLE 1. Results of Softening Point Studies (T_s), Elementary Analyses, and Molecular Weight (\bar{M}) Determinations

Fraction	C/H ratio	T_s ($^{\circ}\text{C}$)	(\bar{M})
a	< 1	>240	ND ^a
b	~ 1	160-180	2500-4000
c	~ 1	90-100	300

^aNot determinable

also proved to be independent from formation conditions. The aromatics/aliphatics ratio within any one fraction also proves to be nearly independent of layer formation conditions. The conclusion is that the changes occurring in the layer as a whole are due to a quantitative change in

product distribution, whereas the qualitative composition of individual layer fractions is relatively independent of discharge conditions.

Fraction c has particularly poor layer properties, such as mechanical, chemical, thermal and electrical stability. This causes low thermal stability in the aging process; it may, in extreme cases, produce considerable puckering (Fig. 11) as low molecular components evaporate.

Figure 12 summarizes IR spectra of the three fractions. Fraction a is seen to have a greater tendency for oxidation and, for equal layer thickness, a higher basic absorption, which may be due to the carbon skeleton of the layer. It is also obvious from the spectra that, despite the expected structural diversity, a number of bands occur in all fractions and thus may be characteristic for a certain structural group only rather than providing a basis for structure discussions. Vivid proof of this is furnished by gas chromatographic studies of the low molecular weight fraction (c). Here, too, a broad product distribution is observed (Fig. 13), which, in contrast to the

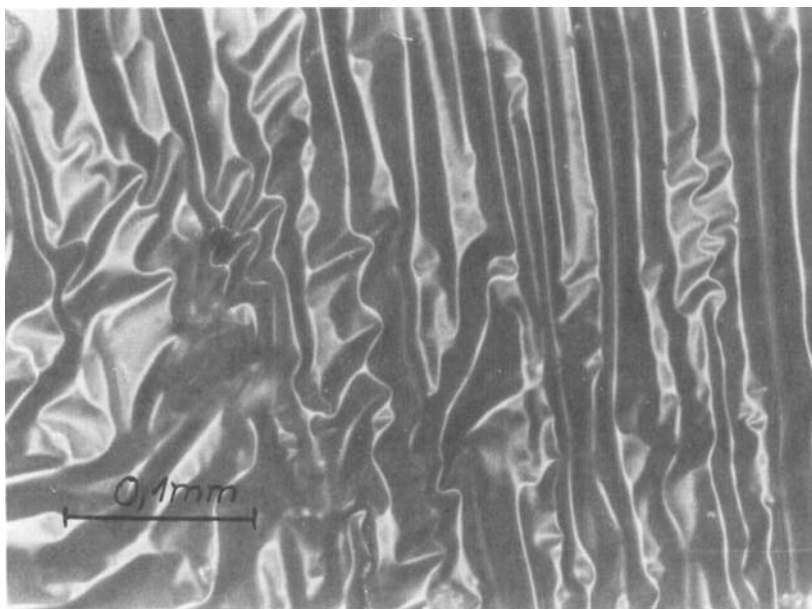

FIG. 11. Surface morphology of a layer with high proportion of fraction c after aging.

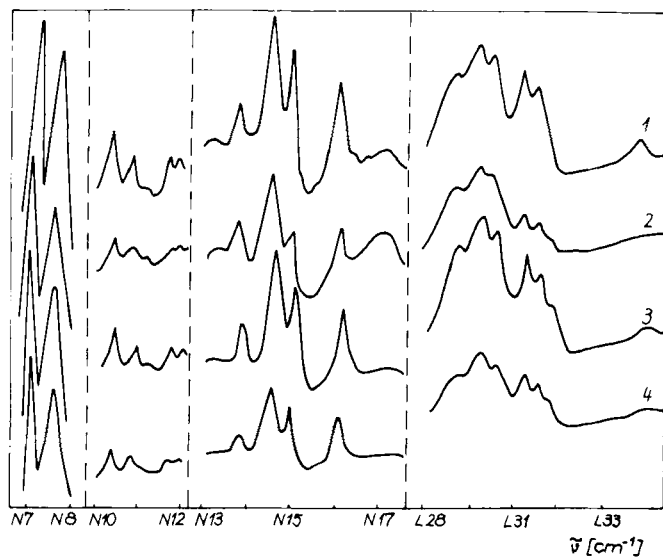

FIG. 12. Infrared spectra of layer and layer fractions: (1) glow polymer; (2) fraction a; (3) fraction b; (4) fraction c.

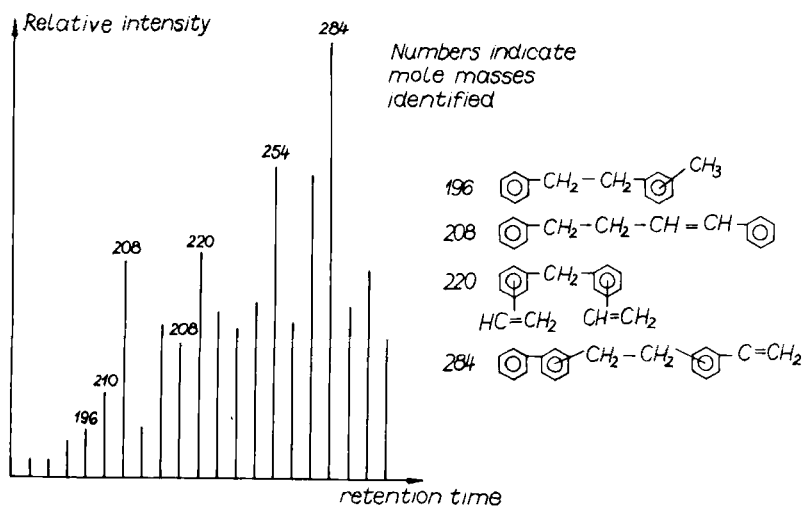

FIG. 13. Gas chromatogram of the low molecular fraction (c).

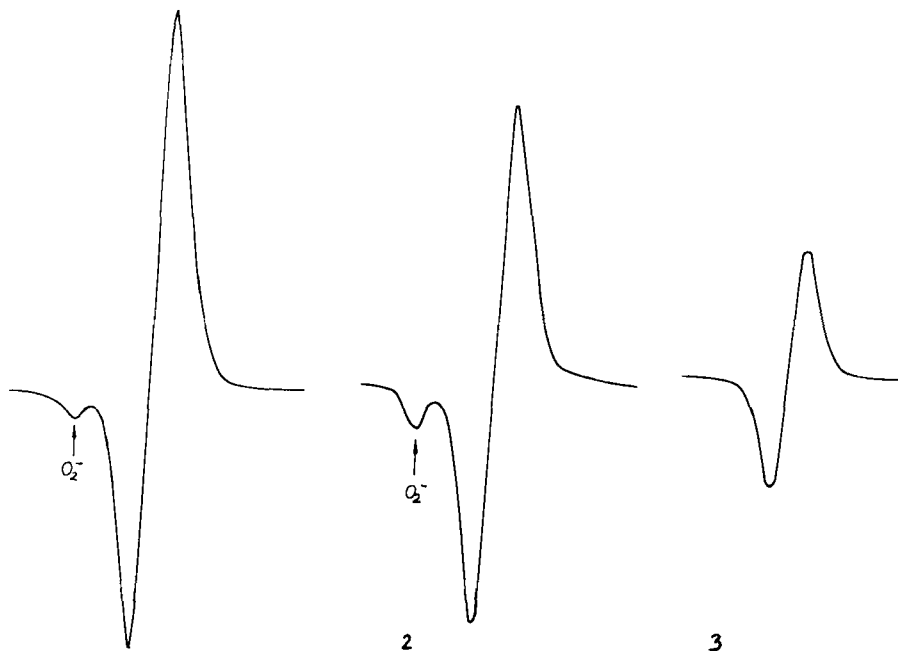

FIG. 14. EPR spectra of individual layer fractions of a glow polymer layer formed from styrene: (1) initial layer; (2) insoluble fraction after benzene treatment, fraction a; (3) soluble fraction extraction from benzene, fraction b.

gaseous phase, is marked particularly by the absence of products having molecular weights > 300 and by the presence of dimeric reaction products of styrene.

The literature frequently refers to an EPR signal of $g = 2$ as a characteristic of layers formed in a low-pressure plasma. It has no hyperfine structure and is largely independent of the layer-forming conditions and the initial compound [13, 37, 55-57]. It is detectable in fractions a and b (Fig. 14), although with less intensity in fraction b; its intensity varies with the degree of layer crosslinking or with the degree of decomposition of the initial compound.

Concepts of the Layer-Forming Mechanism

On the basis of the experimental results, layer formation may be described by a scheme (Fig. 15) which is divided into three stages

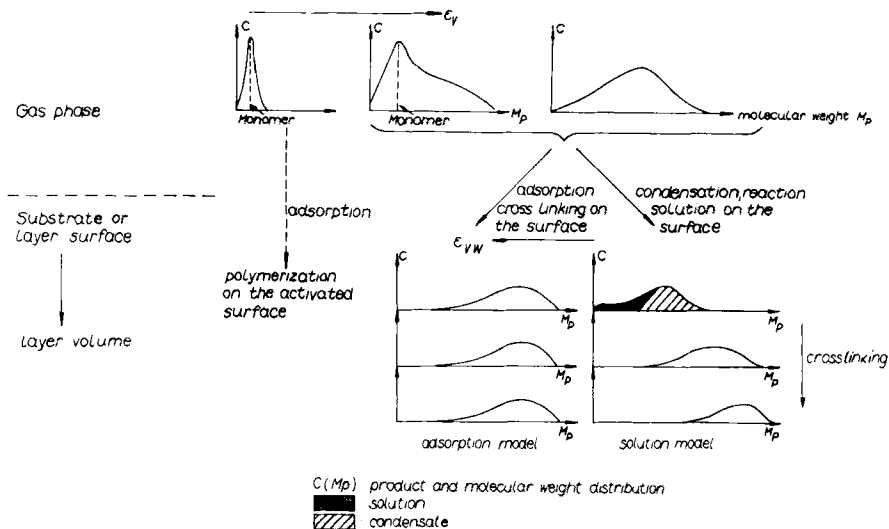

FIG. 15. Concept of layer formation in low-pressure discharges and possible borderline cases.

which take place simultaneously. The importance of the individual steps strongly depends on the discharge conditions. It appears expedient to discuss the stages as limiting cases in the layer-forming process.

First Stage

Formation of a t_d - and ϵ_v -dependent product and molecular weight distribution in the gaseous phase is the first step. Experiments in d.c. discharges do not support the concept of polymeric products of homogeneous structure, since the higher molecular weight fraction of the layer varies little with increasing styrene partial pressure, which was thought to favor gaseous phase polymerization. Rather, the formation of macroscopic particles occurs in the gaseous phase; similar phenomena are also observed in compounds that do not polymerize, such as several organic silicon compounds [24]. For the formation of particles having radii $0.1 \mu\text{m}$ observed by Thompson and Mayhan [32], a temporary interaction with the surface during the formation process cannot be excluded, so that a definite statement regarding formation in the gaseous phase cannot easily be made.

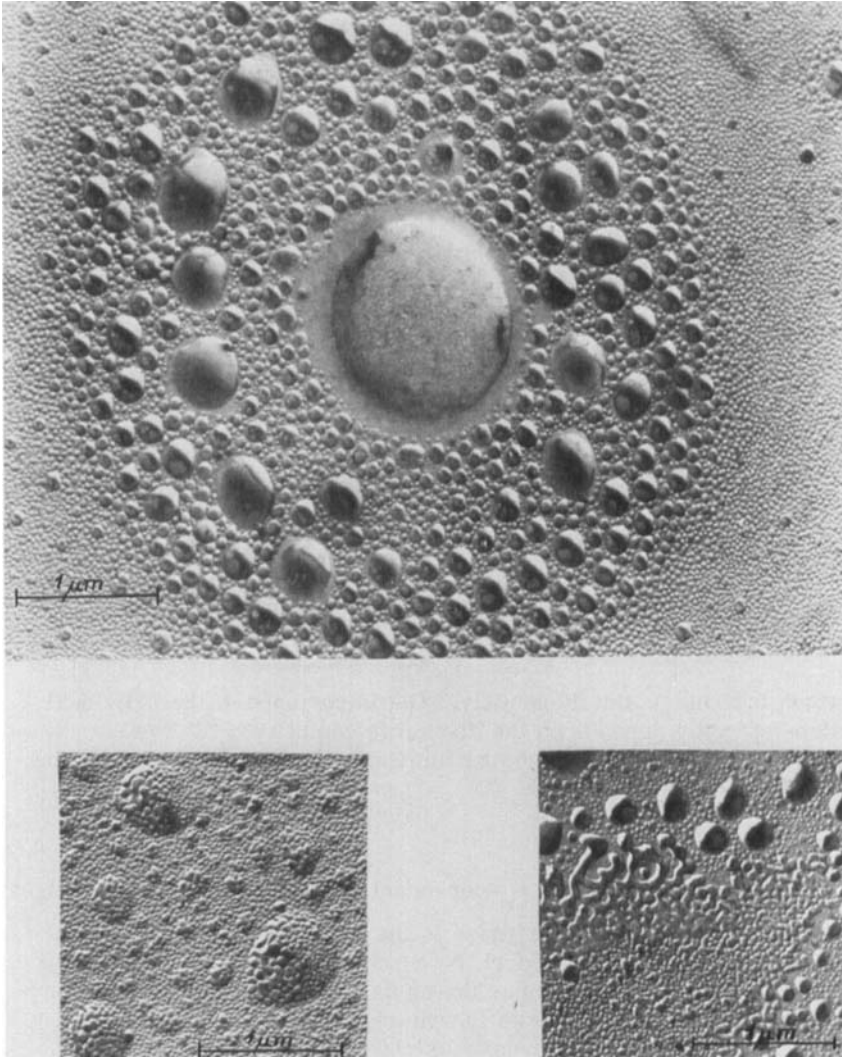

FIG. 16. Electron micrographs of a condensation layer.

Second Stage

By condensation and reactive conversion on the substrate surface, the distribution of products and molecular weights of the gaseous phase is changed into a new distribution on the substrate, forming an adsorption, condensation or solution layer—the latter in conjunction with an earlier layer. The existence of such a low molecular phase on the surface can be proved by electron microscopy under certain discharge conditions (Fig. 16). The nature of its morphology depends largely on the discharge conditions, the initial compound employed, and the wall temperature. A possibility to get quantitative relation between plasma properties and layer properties is the introduction of the specific crosslinking energy ϵ_{vw} :

$$\epsilon_{vw} = a\bar{\epsilon} i_w / P_r \quad (2)$$

where i_w is wall current density, $\bar{\epsilon}$ is average energy of ions and electrons (kinetic energy and recombination energy), and a is a conversion factor.

Under positive-column conditions and with styrene as the initial compound, the low molecular phase was found only where ϵ_{vw} was < 1 eV/particle. This condition is also responsible for a high proportion of fraction c in the layer. This fraction has a high styrene content, which may polymerize after completion of the layer and stabilize the droplet structures detected. The same effect was observed by Kobayashi et al. [13].

Third Stage

Under the influence of the plasma components, crosslinking and partial polymerization (if sufficient components capable of polymerization are present) take place within the adsorption, condensation, or solution layer. These reactions cause a shift in the product and molecular weight distribution towards higher molecular weights (Fig. 15). Under positive-column conditions, a direct correlation between the proportion of the higher molecular fractions (a and b) and the specific crosslinking energy is apparent (Fig. 10). No increase of higher molecular products was detected under surplus

monomer conditions. The shift of the product and molecular weight from fraction c towards fractions b and a involves a decrease in the C/H ratio and a marked decrease of the proportion of aromatics; it should be assumed, therefore, that the shift is less due to polymerization reactions than, with styrene as the initial compound, to cross-linking reactions between especially aliphatic fragments. With sufficiently high values of ϵ_{vw} , the second stage may be skipped

(Fig. 15), because the products reaching the surface crosslink immediately of react with the strongly activated surface. This case largely corresponds to the adsorption model of layer formation [21]. The other extreme case, i.e., low ϵ_{vw} values, produces a low molecular

phase as a condensation or solution layer, which is in a state of equilibrium with the product distribution in the gaseous phase of the plasma. This model [26] is backed by morphological studies of layers having little crosslinking. In this case a vertical gradient in structure will be expected [26]. Between the two limiting cases, there exists a broad spectrum of possible transitions [58]. The distribution of products and molecular weights in the layer is of immediate consequence to the morphology of the layers, which depends systematically on product and molecular weight distribution and thus on the specific crosslink energy. Systematic investigations on styrene as initial compound resulted in the relationship between ϵ_{vw} and surface morphology as presented in Fig. 17. During the experiments, a qualitative relationship was established for other compounds as well. Further proof is added by the results reported by Kobayashi et al. [12], which point to a dependence on parameters that allow reduction to dependence on ϵ_{vw} . The morphology itself varies greatly with thickness of

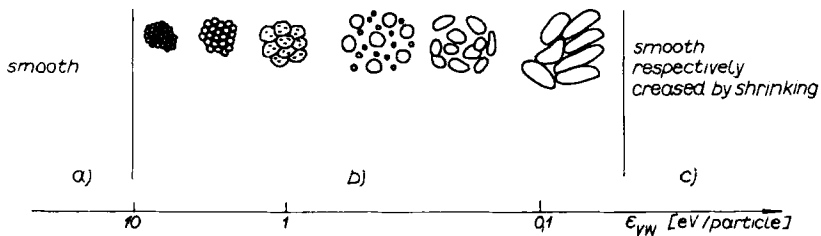

FIG. 17. Surface morphology of a styrene glow polymer layer as a function of ϵ_{vw} (schematic).

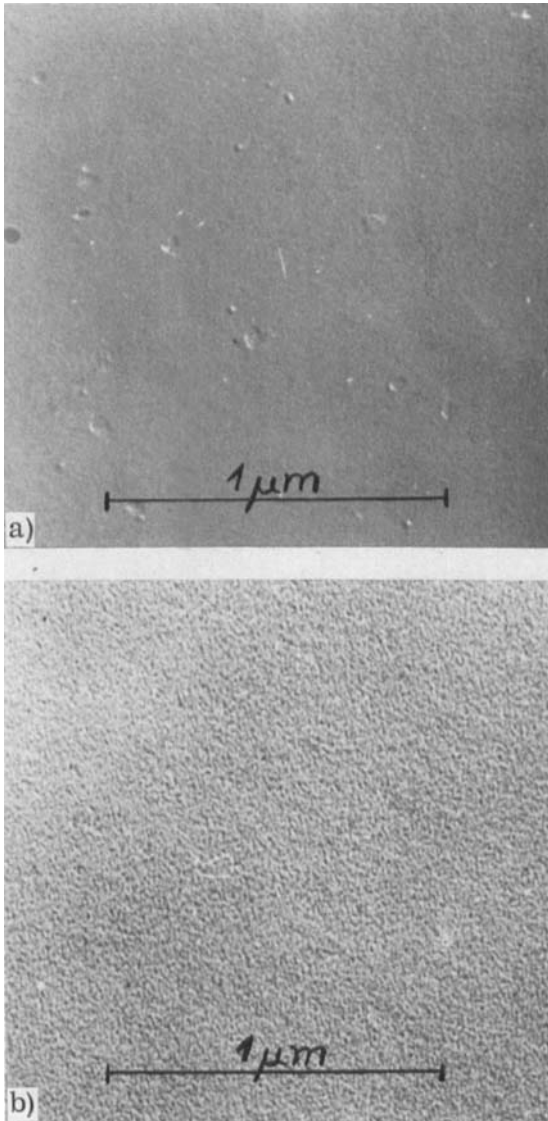

FIG. 18. Electron micrograph of some typical glow polymer surfaces: (a) tetrachloroethylene, thickness of layer $d \sim 250 \text{ \AA}$; (b) tetrachloroethylene, $d \sim 11000 \text{ \AA}$;

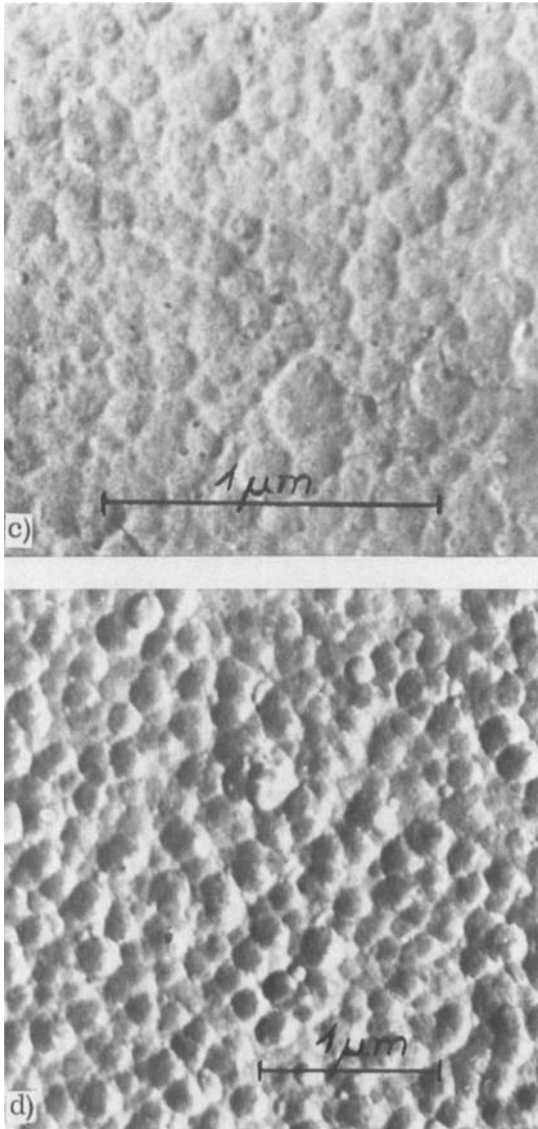

FIG. 18 (continued) (c) monochlorobenzene, $d \sim 9000 \text{ \AA}$; (d) benzene, $d \sim 3000 \text{ \AA}$;

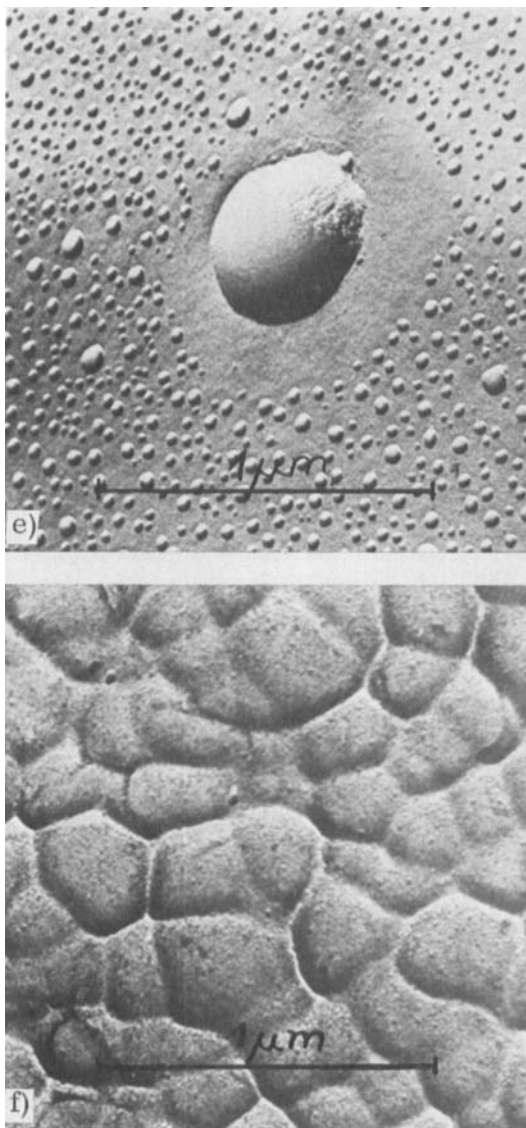

FIG. 18 (continued) (e) methyl methacrylate, $d \sim 23000 \text{ \AA}$; (f) hexafluorobenzene, $d \sim 26000 \text{ \AA}$.

the layers [27, 59, 60, 63]. High ϵ_{vw} values, such as those expected in electrode depositing, produce almost smooth surfaces and reproduce heterogeneities or impurities [29] on the surface, whereas the layer itself becomes more and more structurized as ϵ_{vw} decreases. Typical structures are droplet, powdery, and cauliflower structures (Fig. 18). They may be formed out of the layer, but may also be stimulated by nuclei. At low ϵ_{vw} values, both spherulitic structures and smooth layers can be observed. If the layer has a high proportion of nonpolymerizing, low molecular weight fractions, these fractions evaporate under heavy shrinkage (Fig. 11).

It will be supposed that the two parameters ϵ_v and ϵ_{vw} are suitable for characterizing layer formation conditions in plasmas, though it is in many cases difficult to obtain a quantitative measure of these parameters.

REFERENCES

- [1] J. H. Coleman, U. S. Pat. 3,068,510 (1961).
- [2] R. A. Connell and L. V. Gregor, U. S. Pat. 3,347,21 (1963).
- [3] J. H. Heiss and G. Smolinski, U. S. Pat. 3,518,108 (1970).
- [4] A. R. Westwood, *Eur. Polym. J.*, **7**, 363 (1971).
- [5] R. Liepins and K. Sakaoku, *J. Appl. Polym. Sci.*, **16**, 2633 (1972).
- [6] H. Yasuda and C. E. Lamaze, *J. Appl. Polym. Sci.*, **17**, 1519 (1973); *ibid.*, **17**, 1533 (1973).
- [7] K. C. Brown, *Eur. Polym. J.*, **8**, 117 (1972); *ibid.*, **8**, 129 (1972).
- [8] G. S. Smolinski and J. H. Heiss, Research Report, Telephone Laboratories.
- [9] A. Bradley and J. P. Hammes, *J. Electrochem. Soc.*, **110**, 15 (1963).
- [10] T. Williams and M. W. Hayes, *Nature*, **216**, 769 (1966).
- [11] P. L. Kronick, F. Jesch, and J. E. Bloor, *J. Polym. Sci. A-1*, **7**, 767 (1969).
- [12] H. Kobayashi, A. T. Bell, and M. Shen, *Macromolecules*, **7**, 277 (1974).
- [13] H. Kobayashi, M. Shen, and A. T. Bell, *J. Macromol. Sci.-Chem.*, **A-8**, 373 (1974).
- [14] M. Duval and A. Theoret, *J. Appl. Polym. Sci.*, **17**, 517 (1973).
- [15] A. Denaro, *Eur. Polym. J.*, **4**, 93 (1969).
- [16] A. Denaro, *Eur. Polym. J.*, **5**, 471 (1969).

- [17] A. Denaro, Eur. Polym. J., **6**, 487 (1969).
- [18] R. Haefer and A. A. Mohammed, Acta Phys. Austria, **11**, 193 (1956).
- [19] A. B. Gilman, V. M. Kolotyrkin, N. N. Tunitzkii, Khim Vysok. Energ., **5**, 315 (1971).
- [20] T. Williams, J. Oil. Colour Chemists Assoc., **48**, A707 (1967).
- [21] K. H. Poll, Z. Angew. Physik, **29**, 260 (1970).
- [22] H. J. Tiller, K. Dumke, G. Pelzl, R. Sachse, and K. Meyer: Plaste Kautschuk, **23**, 10 (1976).
- [23] H. Yasuda and C. E. Lamaze, J. Appl. Polym. Sci., **15**, 2277 (1971).
- [24] S. P. Mukerjee and P. E. Evans, Thin Solid Films, **14**, 105 (1972).
- [25] L. S. Tusov, V. M. Kolotyrkin, and N. N. Tunitzkii, Vysokomol. Soedin., **12**, 849 (1970).
- [26] H. J. Tiller, K. Dumke and K. Meyer: Plaste Kautschuk, **23**, 183 (1976).
- [27] D. Häfer, H. J. Tiller, and K. Meyer, Plaste Kautschuk, **19**, 354 (1972).
- [28] D. Hinze, K. H. Poll, A. Steinbrücken, and K. H. Wickleder, Plaste Kautschuk, **21**, 194 (1974).
- [29] D. Hinze and K. H. Poll, Thin Solid Films, **21**, 1 (1974).
- [30] M. Niinomi, H. Kobayashi, A. T. Bell, and M. Shen, J. Appl. Polym. Sci., **18**, 2199 (1974).
- [31] M. Niinomi, H. Kobayashi, A. T. Bell, and M. Shen, J. Appl. Polym. Sci., **44**, 4317 (1973).
- [32] L. F. Thompson and K. G. Mayhan, J. Appl. Polym. Sci., **16**, 2317 (1972).
- [33] H. Yasuda, C. E. Lamaze, and A. Sakaoku, J. Appl. Polym. Sci., **17**, 137 (1973).
- [34] A. B. Gilman and V. M. Kolotyrkin, Kinetika Kataliz, **11**, 1267 (1970).
- [35] H. Yasuda and C. E. Lamaze, J. Appl. Polym. Sci., **17**, 201 (1973).
- [36] H. Kobayashi, A. T. Bell, and M. Shen, J. Appl. Polym. Sci., **17**, 885 (1973).
- [37] A. Bradley, J. Electrochem. Soc., **119**, 1153 (1972).
- [38] M. A. Mittard, J. J. Windle, and A. E. Pavlath, J. Appl. Polym. Sci., **17**, 2501 (1973).
- [39] H. Suhr, Z. Naturforsch., **236**, 1559 (1968).
- [40] H. Suhr, Naturwiss., **55**, 168, (1968).
- [41] B. W. Brooks and R. M. Sambrock, J. Appl. Chem. Biotechnol., **22**, 839 (1972).
- [42] S. W. Lin and J. P. Wightman, J. Appl. Biotechnol., **21**, 168 (1971).

- [43] M. W. Ramey and W. F. O'Connor, Adv. Chem. Ser., **80**, 297 (1969).
- [44] J. K. Hiller and C. E. Rix, J. Org. Chem., **31**, 1591 (1966).
- [45] D. Kunze, O. Peters, and G. Sauerbrey, Z. Angew. Physik, **22**, 69 (1967).
- [46] L. F. Thompson and K. G. Mayhan, J. Appl. Polym. Sci., **16**, 2291 (1972).
- [47] D. O. Neiswender, Adv. Chem. Ser., **80**, 338 (1969).
- [48] H. Kienitz, Massenspektroskopie, Verlag Chemie, Weinheim, 1968.
- [49] H. Deutsch, H. Sabadil, and E.-W. Görss, Beitr. Plasmaphysik, **15**, 183 (1975).
- [50] B. V. Tkatschuk, V. M. Kolotyркиn, and L. V. Perova, Vysokomol. Soedin., **10**, 24 (1968).
- [51] H. Suhr et al., Ber. Bunsenges., **78**, 440 (1974).
- [52] Weixelbaum, Dissertation, Univ. Greifswald, 1975.
- [53] H. J. Tiller, R. Sachse, H. J. Flammersheim, G. Küter, and K. Meyer, Plaste Kautschuk, **23**, 254 (1976).
- [54] M. Takeuchi and Y. Takeazaki, Bull. Inst. Chem. Res. Kyoto Univ., **49**, 230 (1971).
- [55] L. S. Tusov, A. B. Gilman, P. N. Skurov, and V. M. Kolotyркиn, Vysokomol. Soedin., **A9**, 2414 (1967).
- [56] A. N. Skurov and L. S. Tusov, Vysokomol. Soedin., **A11**, 582 (1969).
- [57] J. P. Wightman and X. J. Johnson, Chemical Reactions in Electrical Discharges (Adv. Chem. Ser., **80**), American Chemical Society, Washington, D. C., 1969, p. 322.
- [58] H. Kobayashi, A. T. Bell, and M. Shen, J. Appl. Polym. Sci., **17**, 805 (1973).
- [59] M. Niinomi, H. Kobayashi, A. T. Bell, and M. Shen, J. Appl. Polym. Sci., **18**, 2199 (1974).
- [60] N. Niinomi, H. Kobayashi, A. T. Bell, and M. Shen, J. Appl. Phys., **44**, 4317 (1973).
- [61] D. Berg, Dissertation, University of Jena, 1976.
- [62] A. M. Wrobel, M. Kryczewski, and M. Gazicki, Polymer, **17**, 673 (1976).
- [63] M. Kryczewski, A. Galewski, W. Jablonski, and S. Saphieha, Polymer, **15**, 211 (1974).

Accepted by editor April 22, 1976

Received for publication May 3, 1976